

25MM SLIDING WINDOW HARDWARE

25MM SLIDING WINDOW HARDWARE APPLICATION

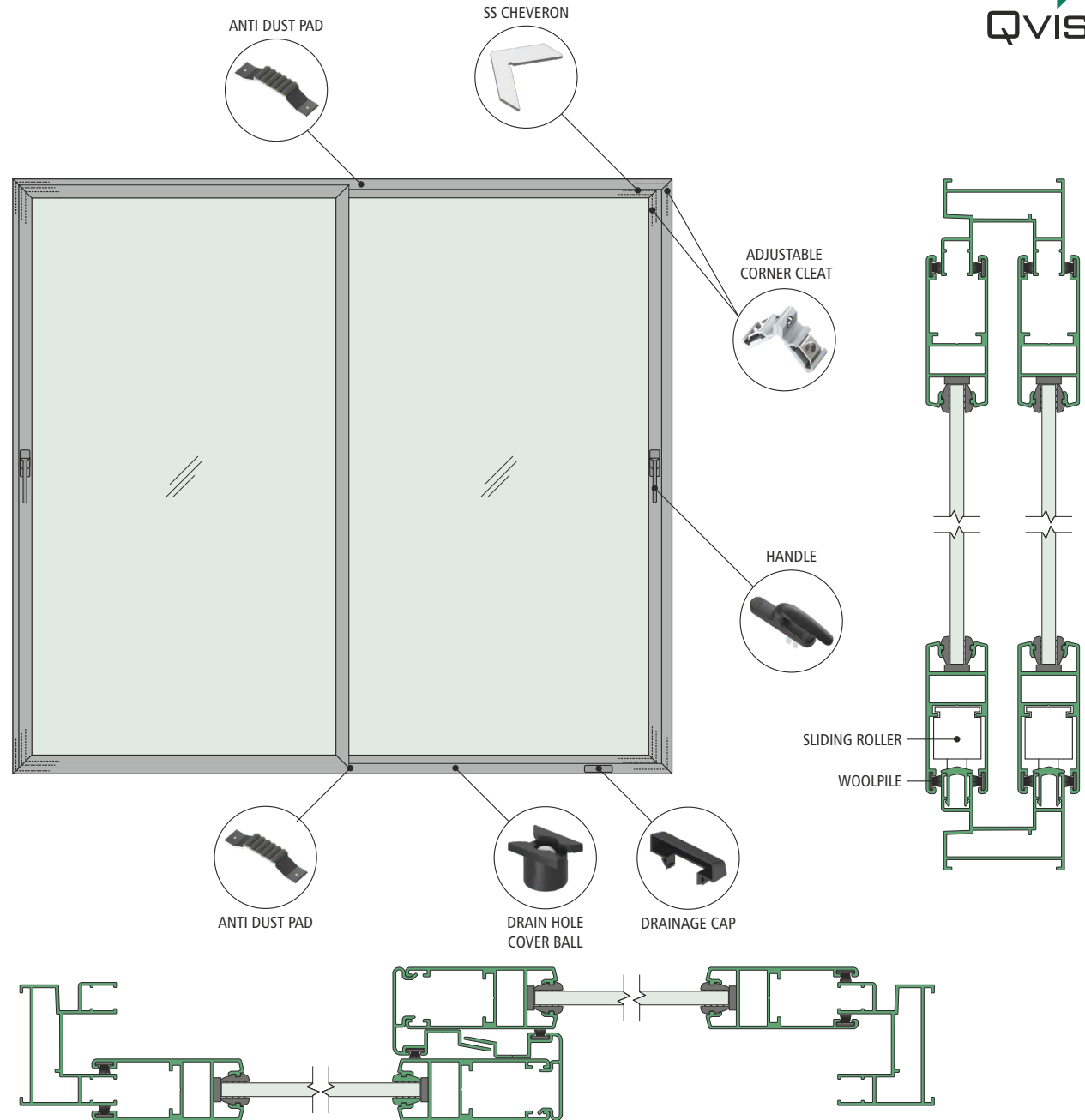

QV123
SINGLE ROLLER (V GROOVE)

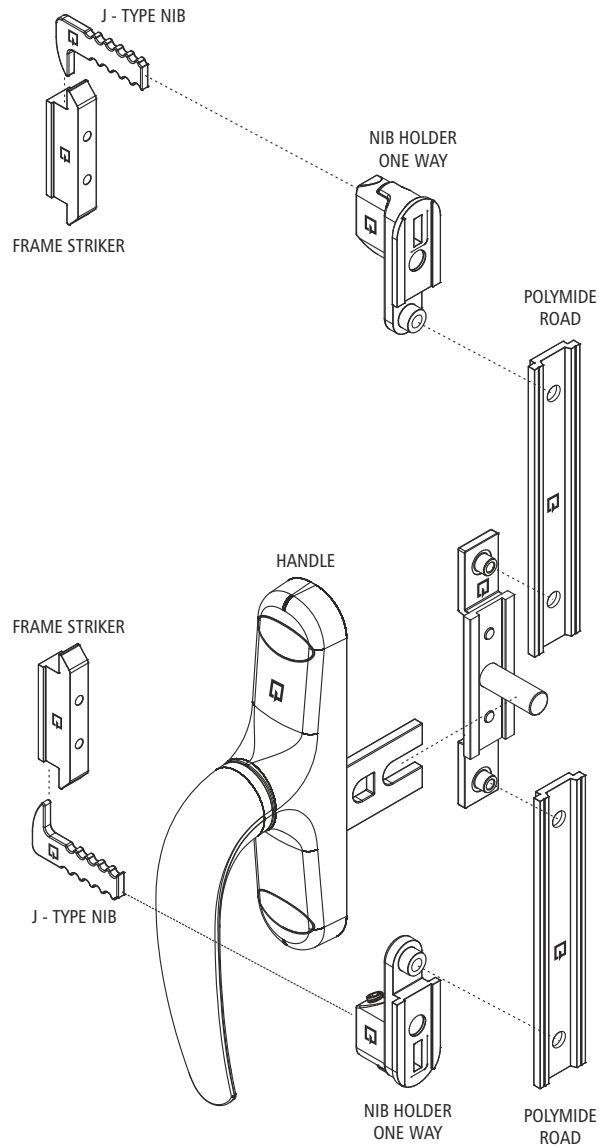
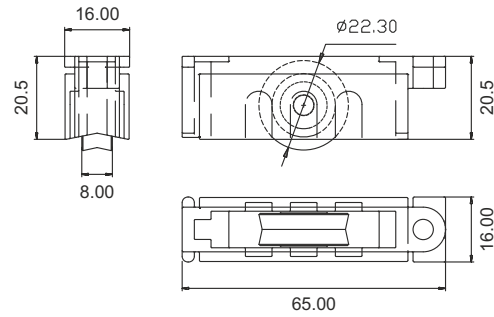
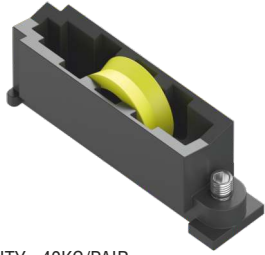

CAPACITY : 40KG/PAIR
BODY : PLASTIC
WHEELS : NYLON

QV124
SINGLE ROLLER (V GROOVE)

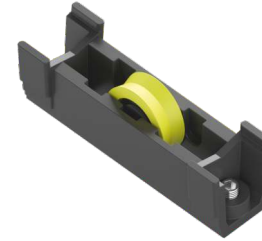

CAPACITY : 40KG/PAIR
BODY : PLASTIC
WHEELS : NYLON

QV125
SINGLE ROLLER (U GROOVE)

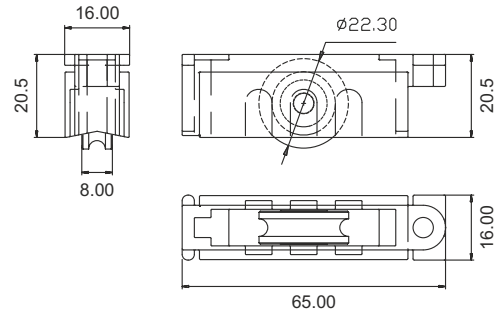

CAPACITY : 60KG/PAIR
BODY : PLASTIC
WHEELS : NYLON

QV201
10X22MM ADJUSTABLE CORNER CLEAT

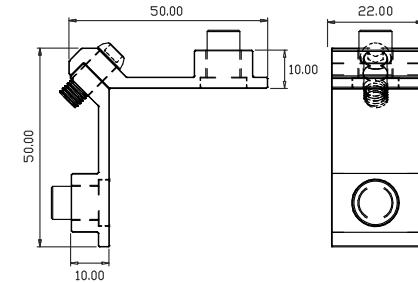

MATERIAL : ALUMINIUM

FINISH : MILL

QV202
10X22MM ADJUSTABLE CORNER CLEAT (PREMIUM)

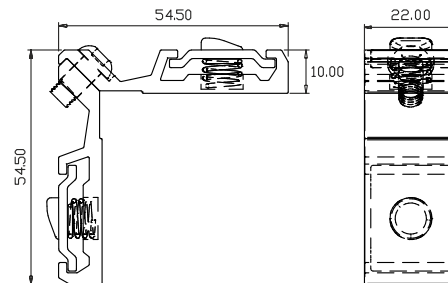

MATERIAL : ALUMINIUM

FINISH : MILL

QV220
10X22MM ADJUSTABLE CORNER CLEAT

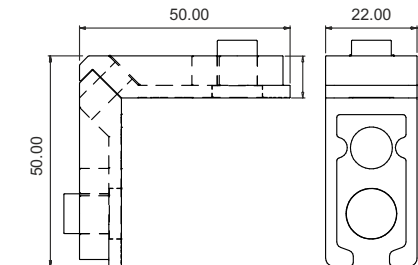

MATERIAL : CASTING

FINISH : MILL

QV501
11MM NYLON CHEVERON

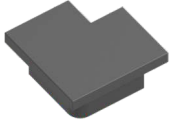

MATERIAL : NYLON



QV515 BLACK / **QV529** WHITE
BUFFER BUMP STOPPER



MATERIAL : NYLON



QV606 BLACK / **QV607** WHITE
BUFFER BUMP STOPPER
(U&V-GROOVE)



MATERIAL : NYLON



QV516
ANTILIFT WITH BUMP STOPPER



MATERIAL : NYLON



QV517
EURO GROOVE ANTLIFT WITH
BUMP STOPPER



MATERIAL : NYLON



QV519 BLACK / **QV520** WHITE
WATER DRAINAGE CAP WITHOUT
WOOVER PLATE



MATERIAL : NYLON



QV521
DRAIN HOLE COVER BALL

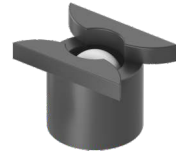

MATERIAL : NYLON



QV522
DRAIN CAPSULE SLOT COVER



MATERIAL : NYLON



QV534 BLACK / **QV535** WHITE
BUFFER BUMP STOPPER



MATERIAL : CASTING



QV542 BLACK / **QV596** ZINC
NIB HOLDER TWO WAY

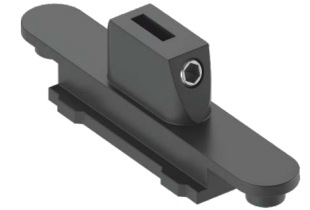

MATERIAL : CASTING



QV543
NIB HOLDER TWO WAY SMALL



MATERIAL : CASTING



QV581
ONE WAY NIB HOLDER



MATERIAL : CASTING



QV544
ONE WAY CONNECTING MULTI
LOCKING DEVICE 25MM (ADJUSTABLE)

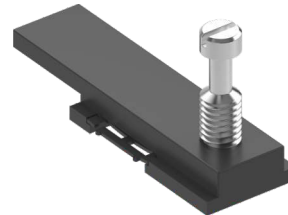

MATERIAL : CASTING



QV545
TWO WAY CONNECTING MULTI
LOCKING DEVICE 25MM (ADJUSTABLE)

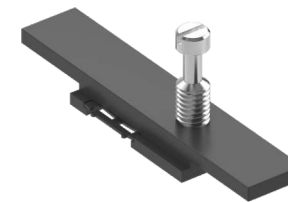

MATERIAL : CASTING



QV548
SLIDING MULTILOCKING
RECIEVER SCREW



MATERIAL : CASTING



QV549
SLIDING MULTILOCKING
RECIEVER ALLEN-KEY



MATERIAL : CASTING



QV552
ROD CONNECTING DEVICE
(STANDARD)



MATERIAL : CASTING



QV553
ROD CONNECTING DEVICE
(PREMIUM)

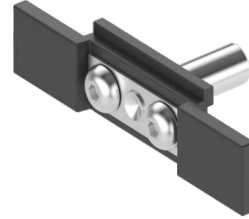

MATERIAL : CASTING



QV554
SS - 304 GRADE FORK CONNECTOR PIN



MATERIAL : SS

FINISH : MILL

QV557
37MM STREIGHT T- TYPE NIB



MATERIAL : SS

FINISH : MILL

QV558
50MM STREIGHT T- TYPE NIB

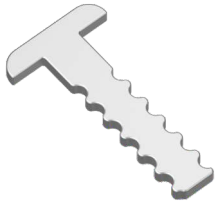

MATERIAL : SS

FINISH : MILL

QV559
37MM STREIGHT J- TYPE NIB



MATERIAL : SS

FINISH : MILL

QV560
50MM STREIGHT J- TYPE NIB



MATERIAL : SS

FINISH : MILL

QV561
SS NIB FOR CONCEAL LOCK

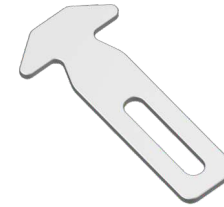

MATERIAL : SS

FINISH : MILL

QV562
SS BEND NIB T-TYPE

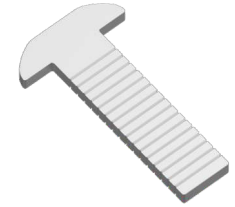

MATERIAL : SS

FINISH : MILL

QV567
7MM SS CHEVERON

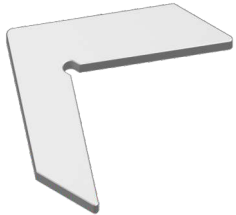

MATERIAL : SS

FINISH : MILL

QV569 BLACK / **QV599** WHITE
WATER DRAINAGE CAP WITH
WOOVER PLATE



MATERIAL : NYLON



QV573 ZINC / **QV574** BLACK
DUCK FRAME STRIKER



MATERIAL : CASTING



QV575 ZINC / **QV576** BLACK
STRAIGHT FRAME STRIKER



MATERIAL : CASTING



QV577 ZINC / **QV578** BLACK
8.5MM SLIM FRAME STRIKER



MATERIAL : CASTING



25MM SLIDING WINDOW
HARDWARE



QV586
L - NYLON CHEVERON

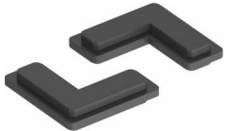

MATERIAL : NYLON B

QV901
15/20 EURO POLYMIDE ROAD



MATERIAL : NYLON B

QV602
ALUMINIUM ANTIDUST PAD (25MM)

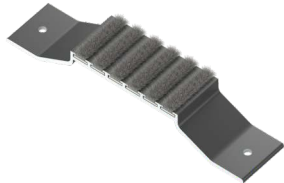

MATERIAL : ALUMINIUM B

QV908 (BLACK) / QV909 (WHITE)
POCKET SLIDING STRIKER



MATERIAL : CASTING W B

QV910
15/20 EURO ALUMINIUM ROD



MATERIAL : ALUMINIUM FINISH : MILL

QV913
4.5MM SS CHEVERON SS-304 GRADE



MATERIAL : SS FINISH : MILL

QV914
6.5MM SS CHEVERON SS-304 GRADE



MATERIAL : SS FINISH : MILL

QV915
12MM SS CHEVERON SS-304 GRADE



MATERIAL : SS FINISH : MILL

QV510
DISTANCE PICE

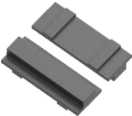

MATERIAL : NYLON B

QV518 BLACK / QV524 WHITE
11.5MM HOLE CAP

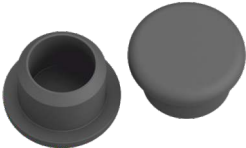

MATERIAL : NYLON W B