

35MM SLIDING WINDOW HARDWARE

35MM SLIDING WINDOW HARDWARE APPLICATION

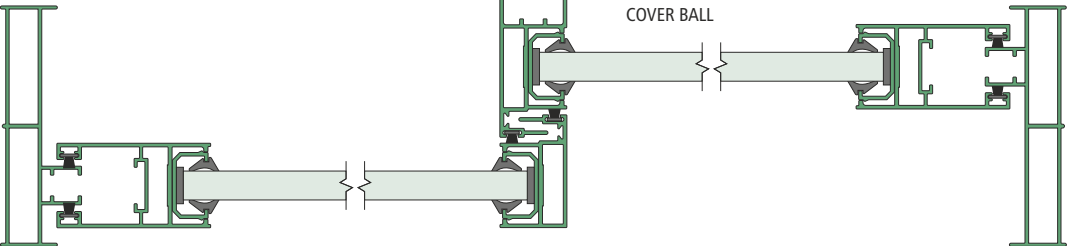

QV116
35MM TWO WHEEL ADJUSTABLE ROLLER (U GROOVE)

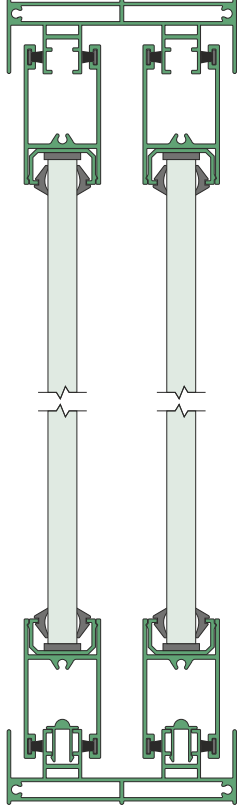
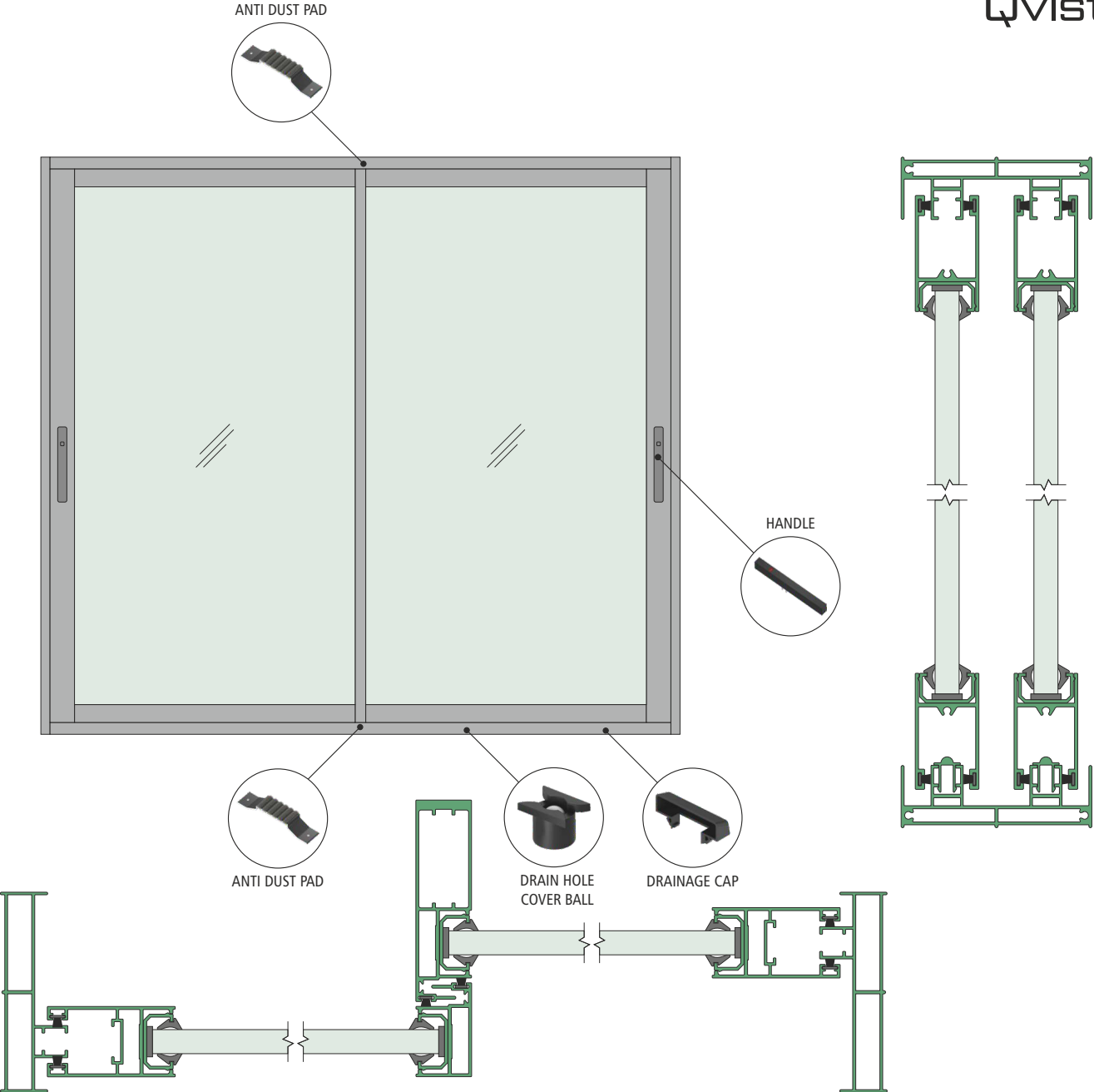
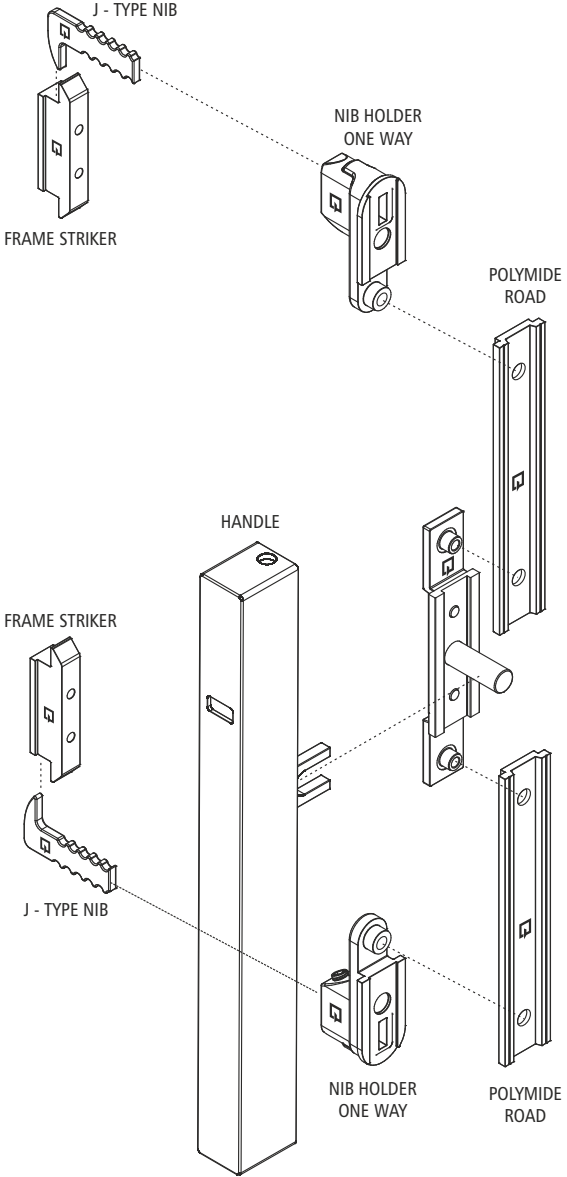
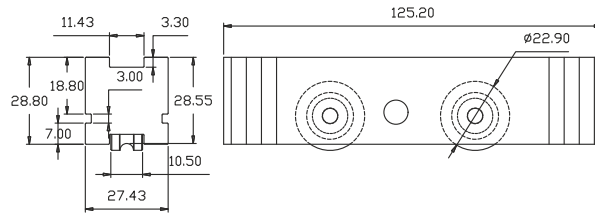

CAPACITY : 180KG/PAIR
BODY : ALUMINIUM
WHEELS : NYLON

QV121
35MM TWO WHEEL ADJUSTABLE ROLLER SS WHEEL (U GROOVE)

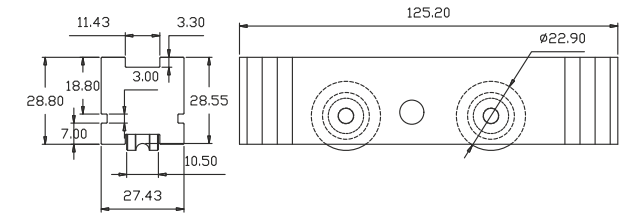

CAPACITY : 250KG/PAIR
BODY : ALUMINIUM
WHEELS : SS

QV506
17.50MM INTERLOCK SCREW CAP



MATERIAL : NYLON



QV508
35MM SLEEK REINFORCEMENT CAP

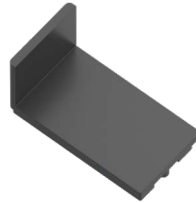

MATERIAL : NYLON



QV512
35MM LOCK GUIDE

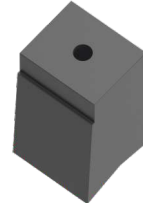

MATERIAL : NYLON



QV516
ANTILIFT WITH BUMP STOPPER



MATERIAL : NYLON



QV525
35MM BUFFER

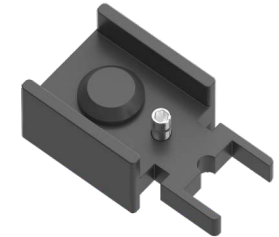

MATERIAL : NYLON



QV532
35MM SERIES ANTILIFT GUIDE

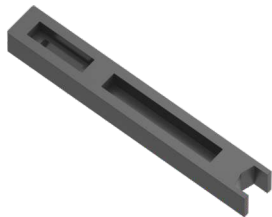

MATERIAL : NYLON



QV534 BLACK / **QV535** WHITE
BUFFER BUMP STOPPER



MATERIAL : CASTING



QV542 BLACK / **QV596** ZINC
NIB HOLDER TWO WAY



MATERIAL : CASTING



QV543
NIB HOLDER TWO WAY SMALL



MATERIAL : CASTING



QV581
ONE WAY NIB HOLDER



MATERIAL : CASTING



QV544
ONE WAY CONNECTING MULTI
LOCKING DEVICE 25MM (ADJUSTABLE)

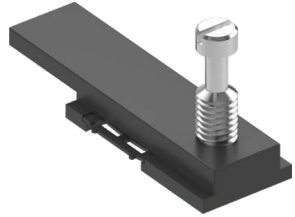

MATERIAL : CASTING



QV545
TWO WAY CONNECTING MULTI
LOCKING DEVICE 25MM (ADJUSTABLE)

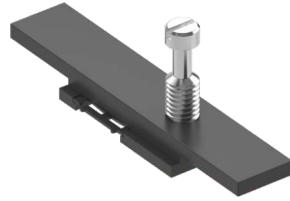

MATERIAL : CASTING



QV548
SLIDING MULTILOCKING
RECEIVER SCREW



MATERIAL : CASTING



QV549
SLIDING MULTILOCKING
RECEIVER ALLEN-KEY



MATERIAL : CASTING



QV552
ROD CONNECTING DEVICE
(STANDARD)

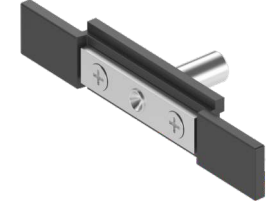

MATERIAL : CASTING



QV553
ROD CONNECTING DEVICE
(PREMIUM)

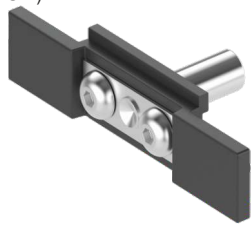

MATERIAL : CASTING



QV554
SS - 304 GRADE FORK CONNECTOR PIN



MATERIAL : SS

FINISH : MILL

QV557
37MM STREIGHT T- TYPE NIB



MATERIAL : SS

FINISH : MILL

QV558
50MM STREIGHT T- TYPE NIB



MATERIAL : SS

FINISH : MILL

QV559
37MM STREIGHT J- TYPE NIB



MATERIAL : SS

FINISH : MILL

QV560
50MM STREIGHT J- TYPE NIB



MATERIAL : SS

FINISH : MILL

QV561
SS NIB FOR CONCEAL LOCK



MATERIAL : SS

FINISH : MILL

QV562
SS BEND NIB T-TYPE

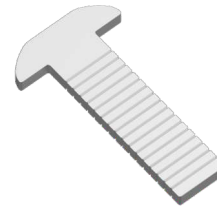

MATERIAL : SS

FINISH : MILL

QV563
ONE WAY CONNECTING MULTI LOCKING
DEVICE 37MM

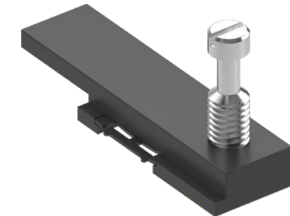

MATERIAL : CASTING



QV584
ONE WAY CONNECTING MULTI LOCKING
DEVICE 37MM

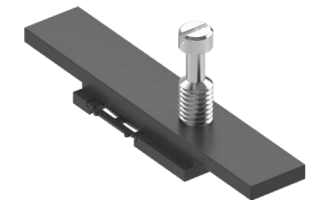

MATERIAL : CASTING



35MM SLIDING WINDOW
HARDWARE



QV569 BLACK / **QV599** WHITE
WATER DRAINAGE CAP WITH
WOOVER PLATE



MATERIAL : NYLON



QV570
GULF SERIES ONE WAY CONNECTING
MULTI LOCKING DEVICE



MATERIAL : CASTING



QV571
GULF SERIES TWO WAY CONNECTING
MULTILOCKING DEVICE



MATERIAL : CASTING



QV575 ZINC / **QV576** BLACK
STRAIGHT FRAME STRIKER



MATERIAL : CASTING



QV582
35MM PREMIUM SLEEK
REINFORCEMENT CAP

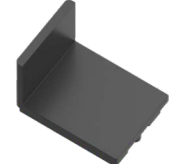

MATERIAL : NYLON



QV902
ALUMINIUM ADAPTER FOR SS RAIL
STANDARD LENGTH 16 FEET



MATERIAL : ALUMINIUM

QV903
6MM X 13MM HEIGHT SS-304
GRADE U RAIL

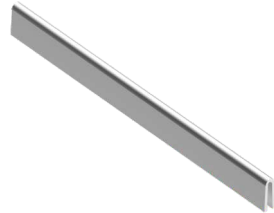

MATERIAL : SS

FINISH : MILL

QV901
15/20 EURO POLYIMIDE ROAD

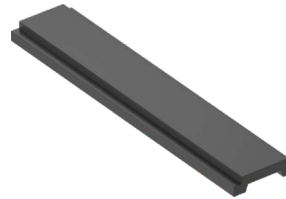

MATERIAL : NYLON



QV910
15/20 EURO ALUMINIUM ROD

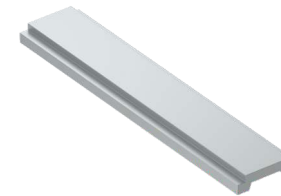

MATERIAL : ALUMINIUM

FINISH : MILL

QV518 BLACK / **QV524** WHITE
11.5MM HOLE CAP

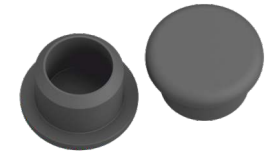

MATERIAL : NYLON



QV519 BLACK / **QV520** WHITE
WATER DRAINAGE CAP WITHOUT
WOOVER PLATE



MATERIAL : NYLON



QV521
DRAIN HOLE COVER BALL

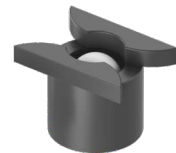

MATERIAL : NYLON



QV522
DRAIN CAPSULE SLOT COVER



MATERIAL : NYLON



QV573 ZINC / **QV574** BLACK
DUCK FRAME STRIKER



MATERIAL : CASTING



QV577 ZINC / **QV578** BLACK
8.5MM SLIM FRAME STRIKER



MATERIAL : CASTING



35MM SLIDING WINDOW HARDWARE



QV908 (BLACK) / **QV909** (WHITE)
POCKET SLIDING STRIKER



MATERIAL : CASTING



QV603
ALUMINIUM ANTIDUST PAD (31MM)



MATERIAL : ALUMINIUM



QV510
DISTANCE PICE



MATERIAL : NYLON

