

37MM SLIDING WINDOW HARDWARE

37MM SLIDING WINDOW HARDWARE APPLICATION

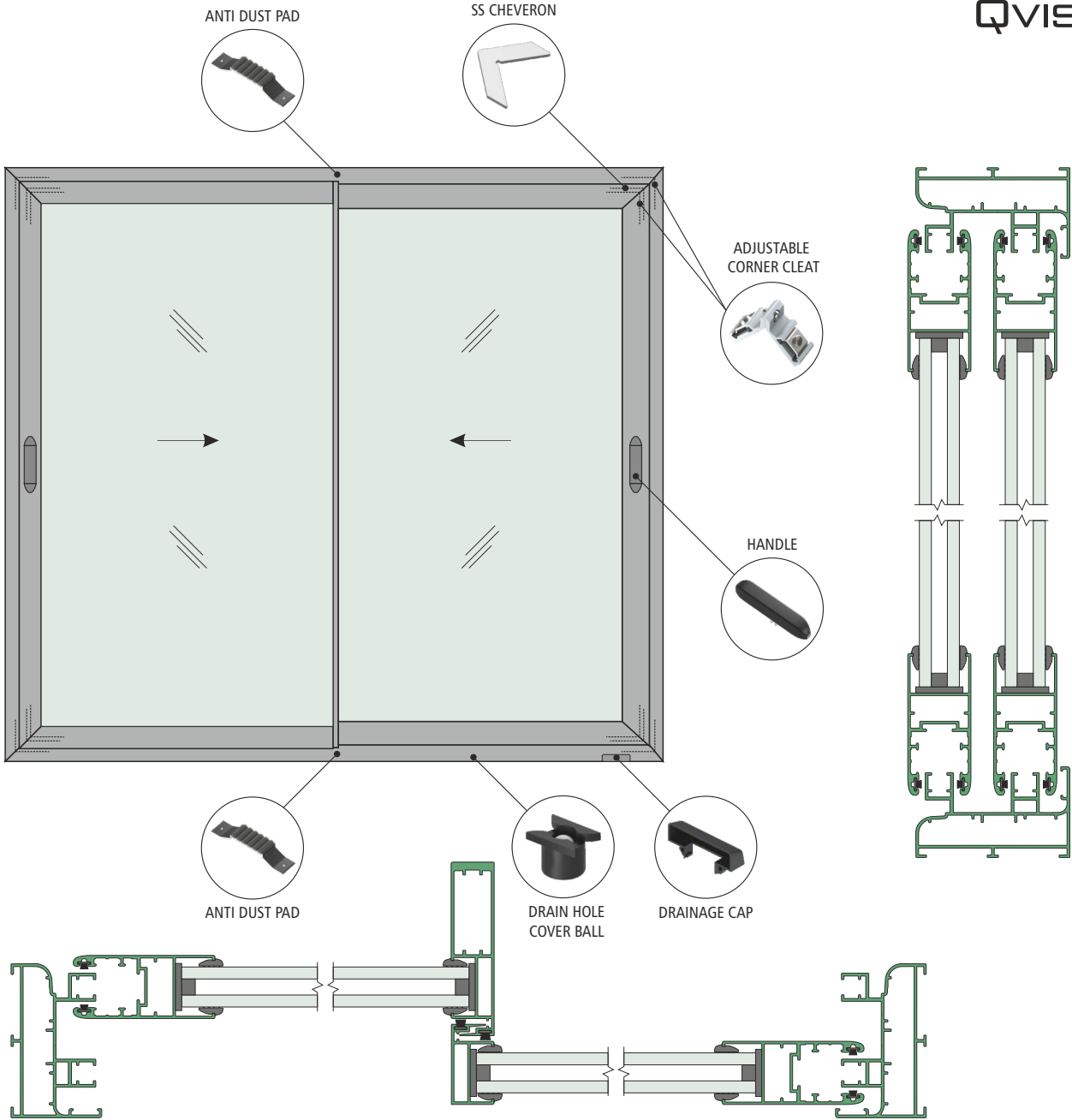

37MM SLIDING WINDOW HARDWARE

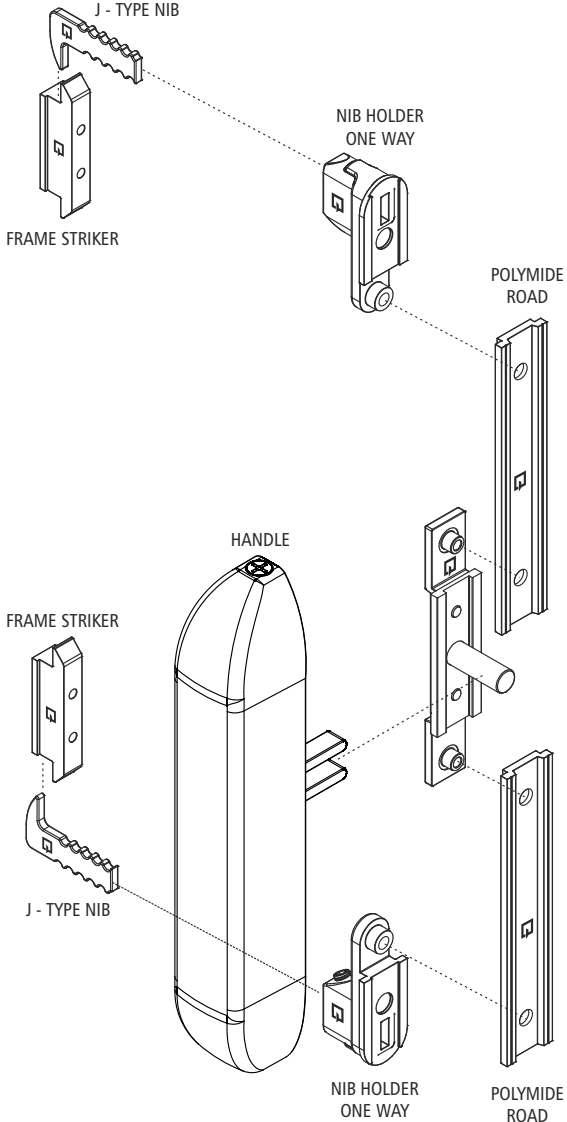

QV212
14X28MM ADJUSTABLE CORNER CLEAT

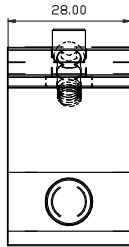
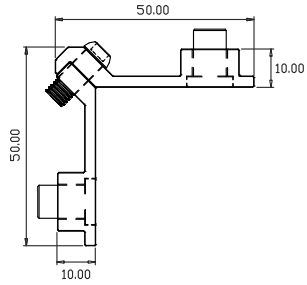
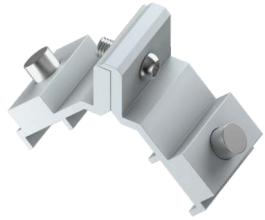

MATERIAL : ALUMINIUM

FINISH : MILL

QV213
14X28MM ADJUSTABLE CORNER CLEAT (PREMIUM)

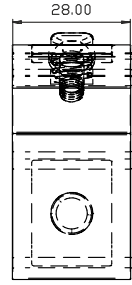
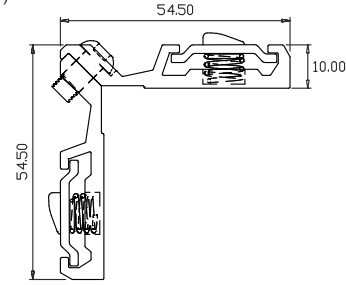

MATERIAL : ALUMINIUM

FINISH : MILL

QV506
17.50MM INTERLOCK SCREW CAP



MATERIAL : NYLON



QV518 BLACK / QV524 WHITE
11.5MM HOLE CAP

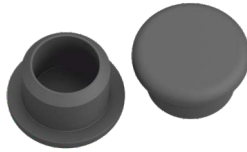

MATERIAL : NYLON



QV519 BLACK / QV520 WHITE
WATER DRAINAGE CAP WITHOUT
WOOVER PLATE



MATERIAL : NYLON



QV521
DRAIN HOLE COVER BALL

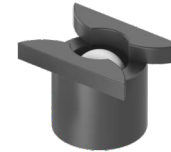

MATERIAL : NYLON



QV522
DRAIN CAPSULE SLOT COVER



MATERIAL : NYLON



QV534 BLACK / QV535 WHITE
BUFFER BUMP STOPPER



MATERIAL : CASTING



QV542 BLACK / QV596 ZINC
NIB HOLDER TWO WAY

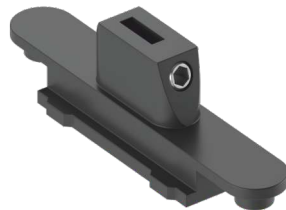

MATERIAL : CASTING



QV543
NIB HOLDER TWO WAY SMALL



MATERIAL : CASTING



QV581
ONE WAY NIB HOLDER



MATERIAL : CASTING



QV544
ONE WAY CONNECTING MULTI
LOCKING DEVICE 25MM (ADJUSTABLE)

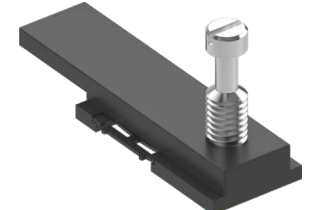

MATERIAL : CASTING



37MM SLIDING WINDOW HARDWARE



QV545
TWO WAY CONNECTING MULTI LOCKING DEVICE 25MM (ADJUSTABLE)

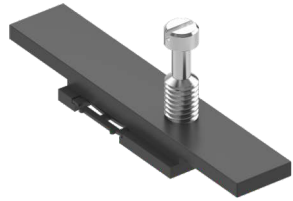

MATERIAL : CASTING



QV548
SLIDING MULTILOCKING RECIEVER SCREW

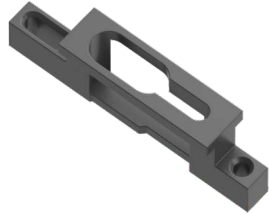

MATERIAL : CASTING



QV549
SLIDING MULTILOCKING RECIEVER ALLEN-KEY



MATERIAL : CASTING



QV552
ROD CONNECTING DEVICE (STANDARD)

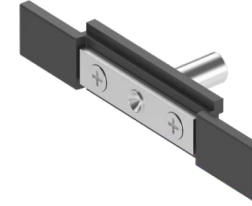

MATERIAL : CASTING



QV553
ROD CONNECTING DEVICE (PREMIUM)

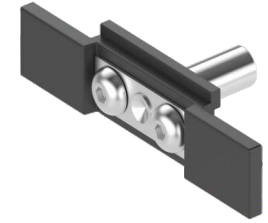

MATERIAL : CASTING



QV554
SS - 304 GRADE FORK CONNECTOR PIN



MATERIAL : SS

FINISH : MILL

QV557
37MM STREIGHT T- TYPE NIB



MATERIAL : SS

FINISH : MILL

QV558
50MM STREIGHT T- TYPE NIB

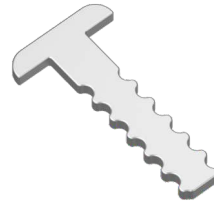

MATERIAL : SS

FINISH : MILL

QV559
37MM STREIGHT J- TYPE NIB



MATERIAL : SS

FINISH : MILL

QV560
50MM STREIGHT J- TYPE NIB



MATERIAL : SS

FINISH : MILL

QV561
SS NIB FOR CONCEAL LOCK



MATERIAL : SS

FINISH : MILL

QV562
SS BEND NIB T-TYPE

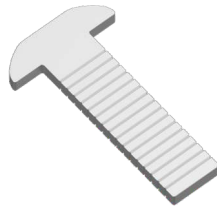

MATERIAL : SS

FINISH : MILL

QV563
ONE WAY CONNECTING MULTI LOCKING DEVICE 37MM

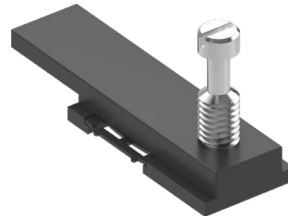

MATERIAL : CASTING



QV584
ONE WAY CONNECTING MULTI LOCKING DEVICE 37MM



MATERIAL : CASTING



QV569 BLACK / **QV599** WHITE
WATER DRAINAGE CAP WITH WOOVER PLATE



MATERIAL : NYLON



37MM SLIDING WINDOW HARDWARE



QV573 ZINC / QV574 BLACK
DUCK FRAME STRIKER



MATERIAL : CASTING



QV575 ZINC / QV576 BLACK
STRAIGHT FRAME STRIKER



MATERIAL : CASTING



QV577 ZINC / QV578 BLACK
8.5MM SLIM FRAME STRIKER



MATERIAL : CASTING



QV901
15/20 EURO POLYIMIDE ROAD

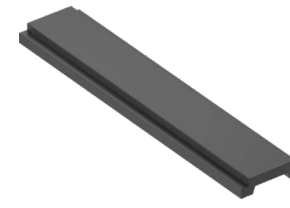

MATERIAL : NYLON



QV902
ALUMINIUM ADAPTER FOR SS RAIL
STANDARD LENGTH 16 FEET



MATERIAL : ALUMINIUM

QV903
6MM X 13MM HEIGHT SS-304
GRADE U RAIL

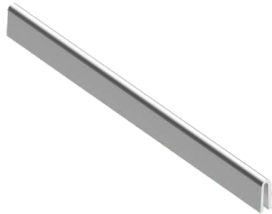

MATERIAL : SS

FINISH : MILL

QV603
ALUMINIUM ANTIDUST PAD (31MM)



MATERIAL : ALUMINIUM



QV908 (BLACK) / QV909 (WHITE)
POCKET SLIDING STRIKER



MATERIAL : CASTING



QV910
15/20 EURO ALUMINIUM ROD

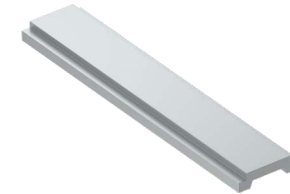

MATERIAL : ALUMINIUM

FINISH : MILL

QV604
REINFORCEMENT CAP

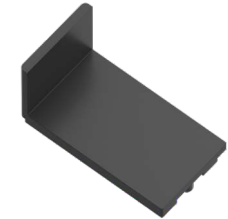

MATERIAL : NYLON



QV226
90° CORNER CLEAT (PREMIUM)

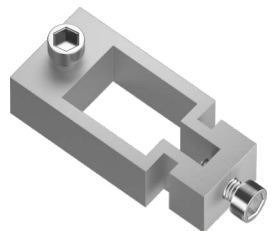

MATERIAL : ALUMINIUM

FINISH : MILL

QV533
37MM INTERLOCK CAP

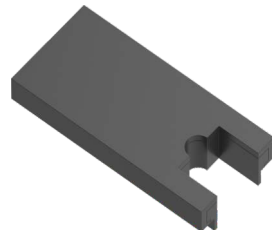

MATERIAL : NYLON



QV913
4.5MM SS CHEVERON SS-304 GRADE



MATERIAL : SS

FINISH : MILL

QV914
6.5MM SS CHEVERON SS-304 GRADE

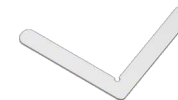

MATERIAL : SS

FINISH : MILL

QV915
12MM SS CHEVERON SS-304 GRADE

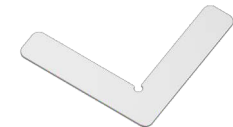

MATERIAL : SS

FINISH : MILL

37MM SLIDING WINDOW HARDWARE

QV586
L - NYLON CHEVERON

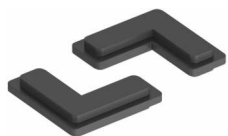

MATERIAL : NYLON



QV510
DISTANCE PICE



MATERIAL : NYLON



QV701 TO QV708
ALUMINIUM SLIDING ESPAG-2P



MATERIAL : ALUMINIUM

FINISH : MILL

MODEL NO.	LENGTH
QV701	400MM
QV702	600MM
QV703	800MM
QV704	1000MM
QV705	1200MM
QV706	1400MM
QV707	1600MM
QV708	1800MM

